

ТАНГРАМ

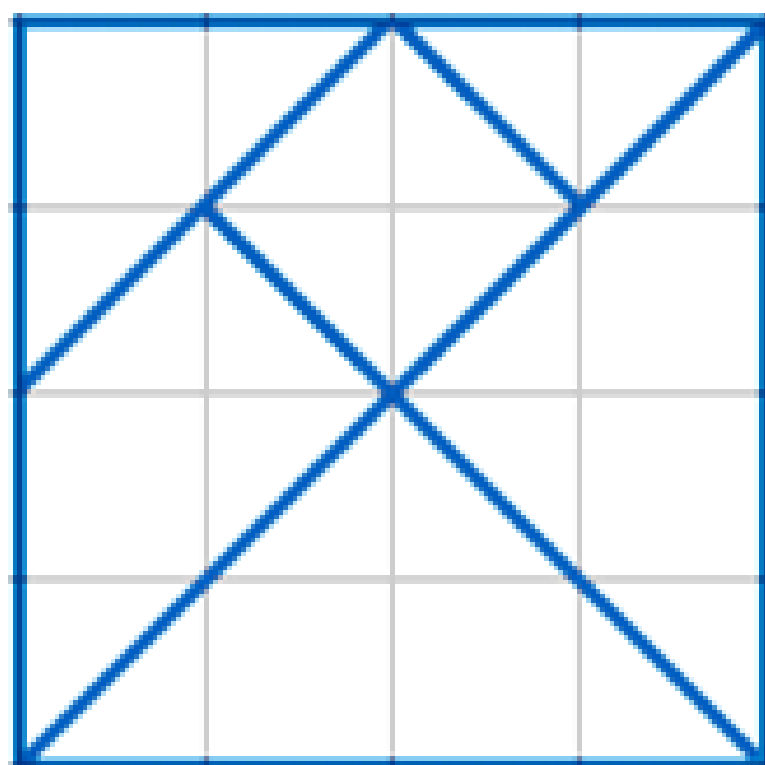

1. Определи ја плоштината на обоениот дел од фигурите:

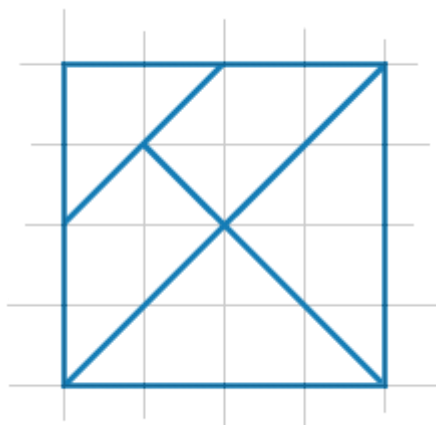
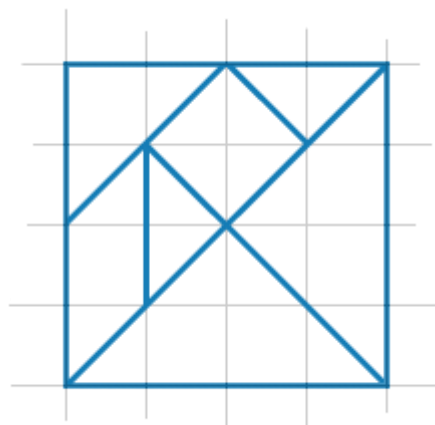
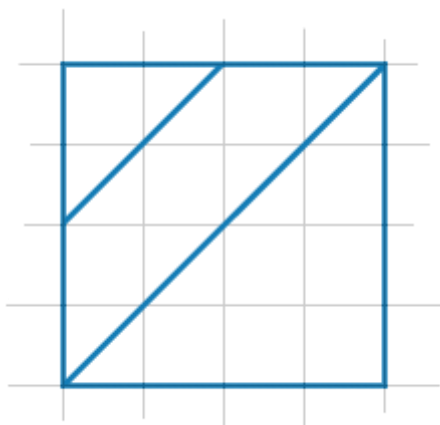
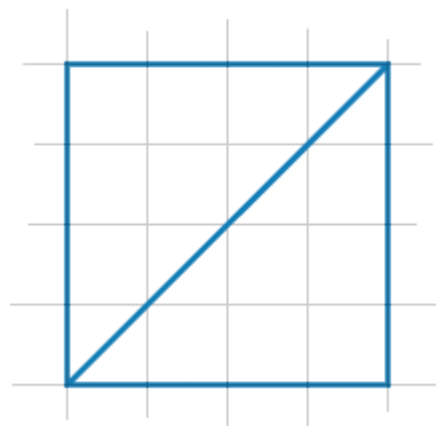
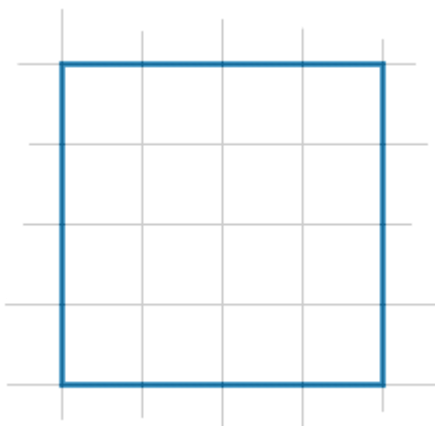
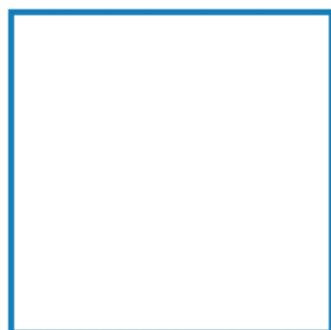
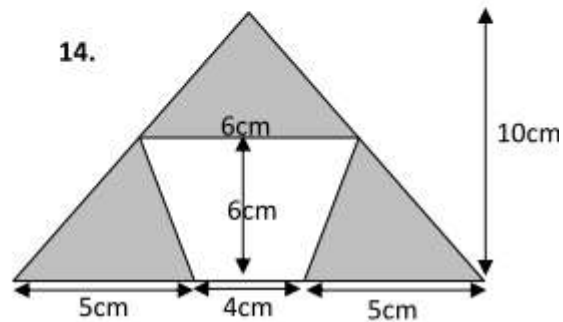
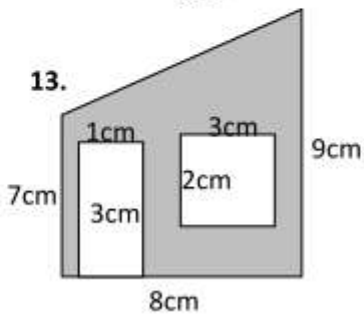
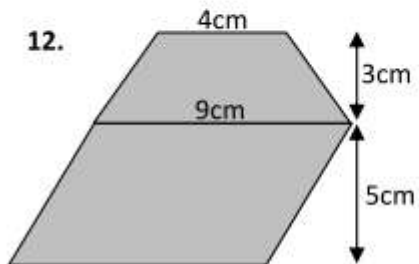
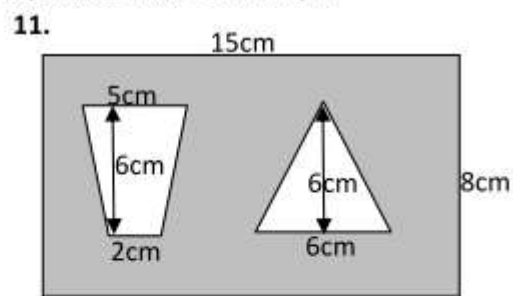
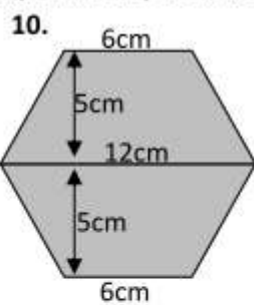
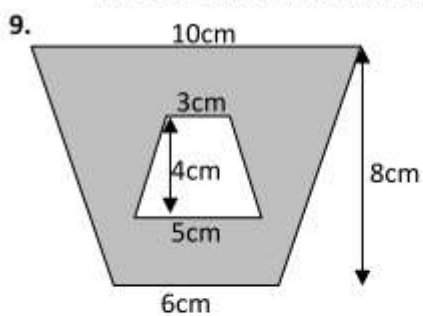

1)

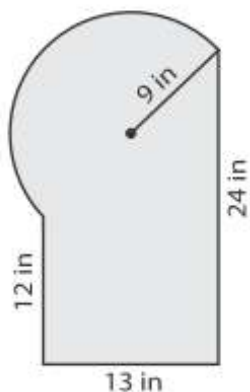

Area = _____

2)

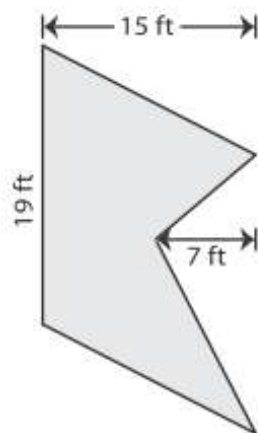

Area = _____

3)

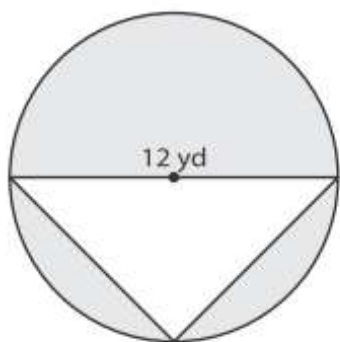

Area = _____

4)

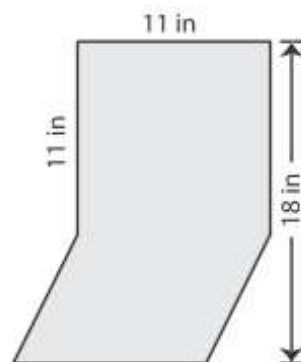

Area = _____

2 5)

6)